



# DATASHEET

## 50W

### LED STREET LIGHT | NILE SERIES SLN\_50W



#### PRODUCT INFORMATION

- Make : **DEVDIGITAL**
- Order Code : **DEV\_SLN\_50W**

#### AREAS OF APPLICATION

- Car parks and underpasses.
- Garages.
- Public areas.
- Building facades.
- Construction areas.
- Garden.

#### PRODUCT BENEFITS

- Energy savings of up to 85%.
- Optimized weight, size and compact design.
- Very homogenous light.
- Long service life.
- Good color rendering.
- Low carbon and environmental protection.

#### Electrical data

Nominal wattage	50W
Operating mode	Electronic control gear (ECG)
Nominal voltage	85V to 300V
Mains frequency	50/60 Hz
Electrical Efficiency	> 90%
Optical Efficiency	> 93%
Thermal Efficiency	> 90%
Ambient Temp(Ta)	50°C

## Photometrical data

CRI	> 70
Total Lumens	7000Lm
Luminous efficacy	140Lm/W
Light Source (smd 3030 1W )	Osram, Seoul or Equivalent
Control Gear	OVP/UVP/440V/IP66
Power Factor	> 0.95
Surge Protection	4 to 6 Kv Inbuilt (10 Kv if required)
LED Life Span	50,000 Hrs
LED Colour	2700K to 6500K

## Dimensions & weight

Length	370MM
Width	140MM
Height	50MM
Product Weight	1.20Kg

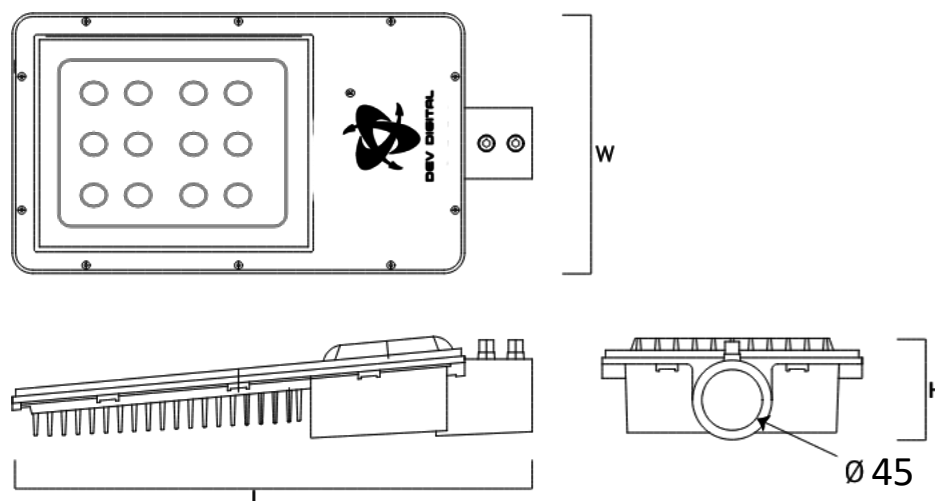

## Light Technical Data

Beam Angle	120°
Lens	No

## Colors & Materials

Body Material	Die cast Aluminum with Powder Coated
Housing Colour	Gray
Cover Material	Glass

## Additional Product Data

Mounting Type	Fixed
Mounting Location	Wall/Pole

## Capabilities

Dimmable	NO
Terminology	Earth,Line Positive,Neutral

## LED PCB Details

Thickness	1.6 mm ( $\pm 5\%$ tolerance)
PCB material	Aluminum-copper
Copper layer thickness	Standard 0.35 micron
Copper conductivity	1 Watt

## Certificates & standards

Type of protection	IP65,IP66
Standards	BIS/CE/RoHS/IEC/ISO/MSME/LM79/LM80 TM