

**USER MANUAL FOR
FULL BORE ELECTROMAGNETIC
FLOW METER
MODEL NO. :- ELMAG 2516**

Authorised Dealer



NK Instruments Pvt. Ltd.

B-501/504, 5th floor, Raunak Arcade, Near THC Hospital, Gokhale Road, Naupada,
Thane(W) 400602. Maharashtra INDIA Telefax Nos.: 91-22-25301330 / 31 / 32
E-Mail: sales@nkinstruments.com Web: <http://www.nkinstruments.com>
Skype: nitinkelkarskype Gtalk: nkinstruments2006



ORDERING DTAILS

Instrument Name : Full Bore Type Electromagnetic Flow Meter

Model No. : ELMAG 2516

Serial No. :

Code	Description	As Applicable
Line Size		
01	½ Inch (15NB)	
02	¾ Inch (20NB)	
03	1 Inch (25NB)	
04	1½ Inch (40NB)	
05	2 Inch (50NB)	
06	2½ Inch (65NB)	
07	3 Inch (80NB)	
08	4 Inch (100NB)	
09	5 Inch (125NB)	
10	6 Inch (150NB)	
11	8 Inch (200NB)	
12	Other	
Calibration Range		
01		
Flow Direction		
01	Forward	
02	Reverse	
Lining Material		
01	PTFE	
02	Rubber	
03	Other	
Flange Material		
01	CS/MS	
02	SS304	
03	SS316	
Coil Housing Material		
01	MS	
02	SS304	
03	SS316	
Electrode Material		
01	SS316L	
02	Hastalloy C	
03	Platinum	
04	Other	

Code	Description	As Applicable
Electronic Enclosure		
01	Aluminum die cast	
02	SS304	
Output		
01	4-20mA DC	
Power Supply		
01	90-260V AC,50Hz	
02	24V DC	
Accessories		
01	Power cable	
02	Magnetic key chain	
03	'U' clamp	
04	Grounding Ring	
05	Other	

CONTENTS

1. INTRODUCTION	01
1.1 Item Supplied.....	01
1.2 Device Identification.....	01
1.3 Reading User Manual.....	01
1.4 Warranty Terms.....	01
2. SAFETY INSTRUCTIONS	02
2.1 General Instructions.....	02
2.2 Storage Precautions.....	02
2.3 Installation Location Precautions.....	02
3. APPLICATION	03
4. OPERATING PRINCIPLE	04
5. TECHNICAL DETAILS	05
5.1 Electronic Unit Specifications.....	05
5.2 Flow Sensor Specifications.....	05
6. ASSEMBLY OVERVIEW	06
7. KEY BOARD DETAILS	07
8. TERMINATION DETAILS	07
9. INSTALLATION DETAILS	08
9.1 How to install Flow Meter.....	08
9.2 Safety Precautions.....	09
9.3 Installation Position.....	09
9.4 Pipe System.....	10
10. OPERATIONAL FLOW CHARTS	13
10.1 General Overview of Operations.....	13
10.2 Configure Mode.....	14
10.3 Configure Instrument Method.....	16
10.4 Average Flow Rate.....	19
10.5 Online Diagnostic Features.....	19
11. MODBUS COMMUNICATION DETAILS	20
12. DO'S & DONT'S	22
13. TROUBLE SHOOTING PROCEDURE	22

1. INTRODUCTION

1.1 Item Supplied :

- ELMAG 2516 flow meter
- User Manual
- Calibration Certificates
- User Manual CD

Inspection :

- Check for mechanical damage due to possible improper handling during shipment. All claims for damage are to be made promptly to the shipper.
- Make sure the scope of delivery and the information on the name plate corresponds to the ordering information.

1.2 Device Identification :

The Model no. and Specification are found on name plate, located on top of electronic housing. Check the Model no. & Specifications you have ordered.

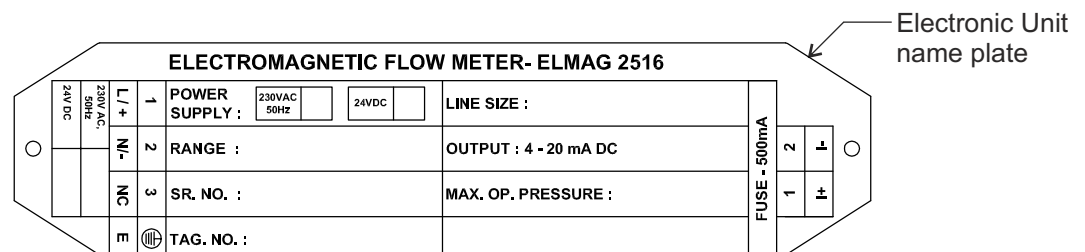

1.3 Reading User Manual :

- This manual should be provided to the end user.
- Before use, read this manual carefully and compare the instrument specification.
- The contents of this manual may be changed without prior notice.

1.4 Warranty terms :

- The terms of this instrument that are guaranteed are described in the quotation. We will make any repairs that may become necessary during the guaranteed term free of charge.
- Please contact our sales office if this instrument requires repair.
- If the instrument is faulty, contact us with concrete details about the problem and the length of time it has been faulty, and state the model and serial number. We would appreciate the inclusion of images or additional information.
- The results of our examination will determine whether the meter will be repaired free of charge or on an at-cost basis.

2. SAFETY INSTRUCTIONS

2.1 General Instructions:

- This flow meter was carefully calibrated at the factory before shipment. When meter is delivered, visually check that no damage has occurred during transportation
- Read User manual carefully and understand instructions & directions provided in this manual.
- In general, devices from the manufacturer may only be installed, commissioned, operated and maintained by properly trained and authorized personnel.
- Look at the ordering detail to ensure that the device is delivered according to your order. Check for the correct supply voltage printed on the nameplate.
- Before powering up the meter, consider the following:
 - Is the meter installed according to the direction of flow as marked on the meter.
 - Has the wiring been carried out correctly and have all safety procedures been adhered to. Is the supply voltage correct.
 - Has the flow meter been properly earth.
 - Lethal power supply voltages may be present, do not apply power with the signal converter cover or terminal box cover removed.
- The following principles should be considered during installation:
 - If there is a noisy power supply voltage (especially peaks generated, usually by motors), use an external power supply filter between the flow meter and power supply.
 - Protect the flow meter and the internal lining of the sensor pipe from mechanical damage, especially during installation or cleaning.
 - Do not expose the flow meter to intense vibration.

2.2 Storage Precautions:

- Store the device in a dry, dust-free location.
- Avoid continuous direct sunlight.
- Store the device in its original packing.
- Storage temperature: 0 to 55°C

2.3 Installation Location Precautions:

- Installation of the Electromagnetic flow meter must be performed by expert engineer or skilled personnel. No operator shall be permitted to perform procedures relating to installation.
- The Electromagnetic flow meter is a heavy instrument. Be careful that no damage is caused to personnel through accidentally dropping it, or by exerting excessive force on the electromagnetic flow meter. When moving the electromagnetic flow meter, always use a trolley .
- When the electromagnetic flow meter is processing hot fluids, the instrument itself may become extremely hot. Take sufficient care not to get burnt.

Note : IP66/IP68 Certification is valid only if warranty seal is intact and also safety precautions must be strictly maintained.

3. APPLICATION

ELMAG 2516 is microprocessor based full bore type electromagnetic flow meter specially used for various industrial applications. This flow meter accurately measures the flow rate of conductive liquids & slurries in closed pipes. Due to simple, rigid & obstruction less design the flow meter is a maintenance free instrument in place of conventional mechanical flow measuring device. ELMAG 2516 standard configuration is a sensor with transmitter integrated in one unit. It's performance is independent of temperature, pressure, density and viscosity of the medium. ELMAG 2516 is a flanged meter available in sizes from DN10 to DN 200. The rugged flow sensor is constructed from completely welded construction. In the instrument, the sensor and the electronics form one mechanical entity. A retransmission output of 4-20 mA is provided. The use of 'Pulsed DC' excitation technology offers highest ability & better measuring accuracy in the form of electrical signal 4 - 20 mA DC linearly proportional to volumetric flow.

Sensor : The sensor consists of metering pipe; electrodes and coils. It is accommodated in welded and a fully encapsulated steel enclosure.

Electronics : The conditioning electronics circuitry is housed in a cast aluminum connection box. The termination of this electronics is given in the same housing through cable glands for the required connecting cables.

Applications:

- ☞ Applications include measurement of flow on conducting liquids and slurries (even highly corrosive and abrasive) in chemical and petrochemicals, pharmaceutical, fertilizers, foodstuffs, dairy, sugar, breweries, paper, steel, mining industries etc.
- ☞ Monitoring water flow in cooling systems in steel plants, power plants etc.
- ☞ Measuring flow of clean water, effluent, sludge etc. In pollution and environmental control.
- ☞ The isolated 4-20 mA output proportional to flow can be fed to PLCs, DCS or remote mounted indicator.

4. OPERATING PRINCIPLE

The flow meter is designed for electrically conductive fluids. Measurement is based on Faraday's law of induction, according to which a voltage is induced in an electrically conductive body, which passes through a magnetic field.

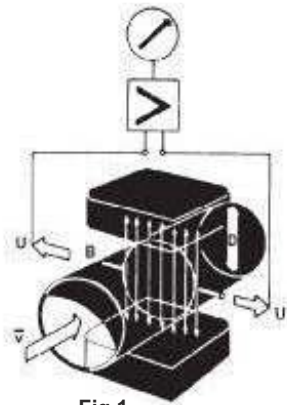

Fig.1

The following expression is applicable to the voltage:

$$U = K \times B \times v \times D$$

Where:

U = induced voltage

K = an instrument constant

B = magnetic field strength

v = mean velocity

D = pipe diameter

Thus the induced voltage is proportional to the mean flow velocity, when the field strength is constant. Inside the electromagnetic flow meter, the fluid passes through a magnetic field applied perpendicular to the direction of flow. An electric voltage is induced by the movement of the fluid (which must have a minimum electrical conductivity). This is proportional to the mean flow velocity and thus to the volume of flow. The induced voltage signal is picked up by two electrodes, which are in contact with conductive fluid and transmitted to the signal converter. This method of measurement offers the following advantages:

- 1) No pressure loss through pipe.
- 2) Since the magnetic field passes through the entire flow area, the signal represents a mean value over the pipe cross-section; therefore, only relatively short straight inlet pipes x DN from the electrode axis are required upstream of the primary head.
- 3) Only the tube liner and the electrodes are in contact with the fluid.
- 4) The signal produced is an electrical voltage, which is an exact linear function of the mean flow velocity.

5. TECHNICAL DETAILS

5.1 Specifications:

5.1.1 Electronics Unit Specifications:

Instrument Name	: Full Bore Type Electromagnetic Flow Meter
Model No.	: ELMAG 2516
Media	: Conductive Liquids & slurries
Calibration Range	: As per customer requirement
Display	: 16X2 Alphanumeric LCD, 6 digit for flow rate & 9 digit for totaliser
Power Supply	: 1) 90-260V AC, 50Hz 2) 24V DC
Power Consumption	: Less than 10VA
Response Time	: 2Sec.
Accuracy	: +/-0.5% of full scale
Linearity	: +/-0.5% of full scale
Isolation	: 1.4KV Between output & Power supply
Output	: 4-20mA DC
Flow Direction	: 1) Forward 2) Reverse
Temperature	: 1) Ambient : 0 to 55 C 2) Storage : 0 to 55 C
Relative Humidity	: 10-95% RH, non condensing
Cable Entry	: M20 x1.5 Double Compression Cable Gland, 1/2" NPT
Mounting	: In Line - Horizontal / Vertical
Transmitter Enclosure	: Aluminum Die cast
Protection Class	: IP66 /IP68

5.1.2 Flow Sensor Specifications:

Line Size	: 15NB to 200NB
Material of Construction	: 1) Coil housing : MS / SS 2) Electrode : SS 316L / Hastalloy C / Platinum 3) Flange : CS / MS / SS 304 / SS 316 4) Lining : Rubber / PTFE
Mechanical Connections	: Flange / SMS union / Threaded / Tri clover
Media conductivity	: > 20 µs/cm
Limit flow velocities of measured liquid	: 6 m/s
Viscosity	: 200cp (max.)
Direction of Flow	: Direction of Arrow on Meter
Protection class	: IP68
Process Temperature	: 1) 0 to 85° C(For Rubber Lining) 2) 0 to 120° C(For PTFE Lining)
Operating Pressure	: 0 to10Kg/cm ²

6. ASSEMBLY OVERVIEW

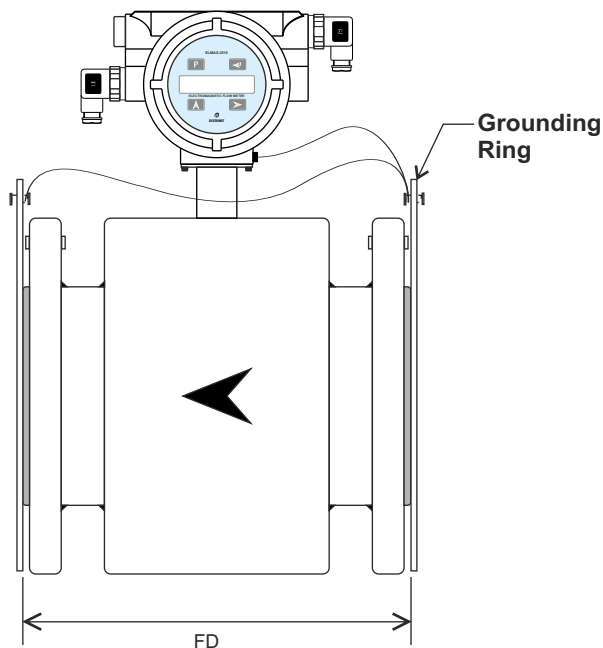

Fig.2 FRONT VIEW

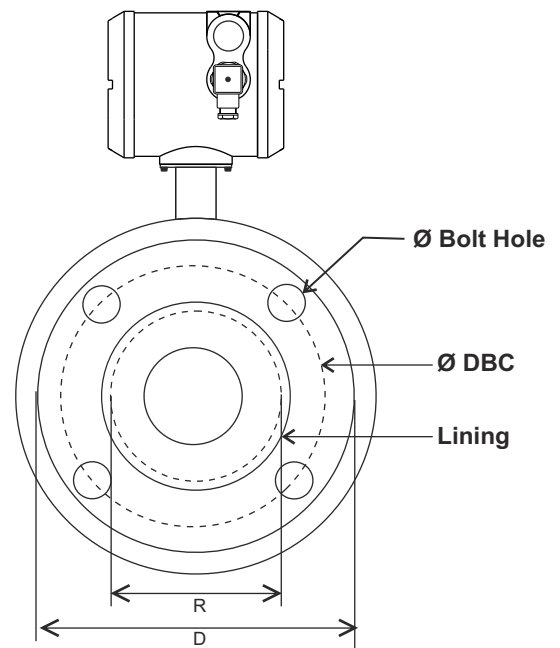

Fig.3 SIDE VIEW WITH FLANGE DETAILS

DIMENSIONAL DETAILS OF FLANGE(AS PER ASA150 # B-16.5):

Line Size		Flange Diameter D (mm)	Diameter of Raised Face R (mm)	Diameter of Bolt Hole Circle DBC (mm)	Diameter of Bolt Hole (mm)	No. of Holes	Thickness of Flange	Housing OD (mm)	Flange to Flange Distance (FD) (mm)
Inch	NB								
1/2"	15	88.9	34.9	60.3	15.9	4	11.1	125	200
3/4"	20	98.4	42.9	69.8	15.9	4	12.7	125	200
1"	25	107.9	50.8	79.4	15.9	4	14.3	145	200
1 1/2"	40	127.0	73	98.4	15.9	4	17.5	155	200
2"	50	152.4	92.1	120.6	19.0	4	19.0	165	200
2 1/2"	65	177.8	104.8	139.7	19.0	4	22.2	185	200
3"	80	190.5	127.0	152.4	19.0	4	23.8	205	200
4"	100	228.5	157.2	190.5	19.0	8	23.8	245	250
5"	125	254.0	185.7	215.9	22.2	8	23.8	265	250
6"	150	279.4	215.9	241.3	22.2	8	25.4	285	300
8"	200	342.9	269.9	298.4	22.2	8	28.3	355	350

* Note : Flange to flange distance (FD) Tolerance : 1) 1/2"(15NB) to 6"(150NB) : +/-3mm
2) 8"(200NB) : +/-5mm

Note : All dimensions are in 'mm'

7. KEY BOARD DETAILS

- P Program Key** : This key is used to toggle between Run mode and Program mode.
- ▲ Increment Key** : This key is used to :-
 1) Increment the numerical value of any digit, from 0 to 9, by one at each time.
 2) Go to the next parameter in Program mode.
 3) Continue press for 6 sec. : Averaging Mode
 4) To start Averaging.
- ▶ Shift Key** : This key is used to :-
 1) Shift the cursor to the next digit.
 2) To stop averaging
- ↵ Enter Key** : This key is used to :-
 1) Validate the function or value of parameter.
 2) To view reverse totaliser

8. TERMINATION DETAILS

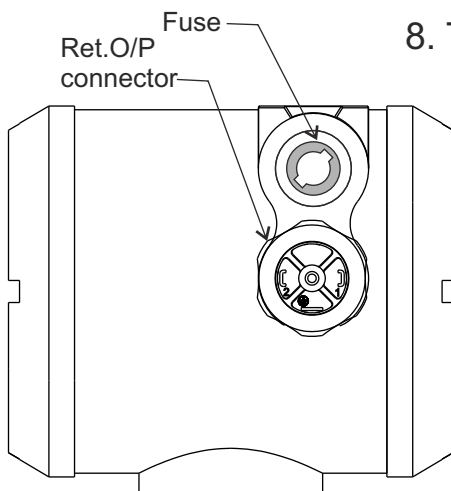
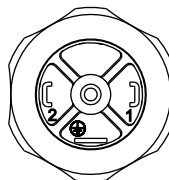

Fig.4 ENCLOSURE LHS VIEW



Fuse

FUSE 500mA SLOW BLOW



Ret. O/P connector(M)

1	I+	4-20mA DC Retransmission Output
2	I-	
	NC	

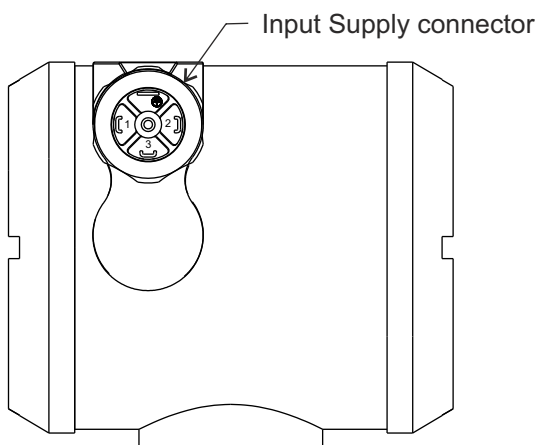
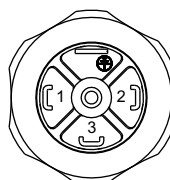

Fig.5 ENCLOSURE RHS VIEW



Input Supply connector(M)

1	L	230V AC Power Supply
2	N	
	E	

9. INSTALLATION DETAILS

9.1 How to Install Flow Meter :-

- 1) Flowmeter can be installed in any position either vertical or horizontal.
- 2) The meter may be installed in horizontal or vertical pipelines. If a vertical pipeline installation is desired, the meter should be installed with the direction of flow being upwards, to ensure a full pipe under low flow conditions. If a horizontal installation is desired the measuring electrodes should be installed in the horizontal plane in order to prevent entrained air or gasses collecting at the electrodes. The effect of this would be that the meter would give inaccurate and unstable readings.
- 3) For horizontal installation, the electrode axis should always be in horizontal plane.
- 4) The flow meter should be installed away from electrical motors, transformers, inverter and other power sources in order to avoid interference with measurement. Install the flow meter in a location where it is not exposed to direct sunlight.
- 5) Be sure to choose a gasket with inner and outer diameters that does not protrude inside the piping. If the inner diameter of the gasket is too large, or outer diameter of the gasket is too small, fluid leakage may result.

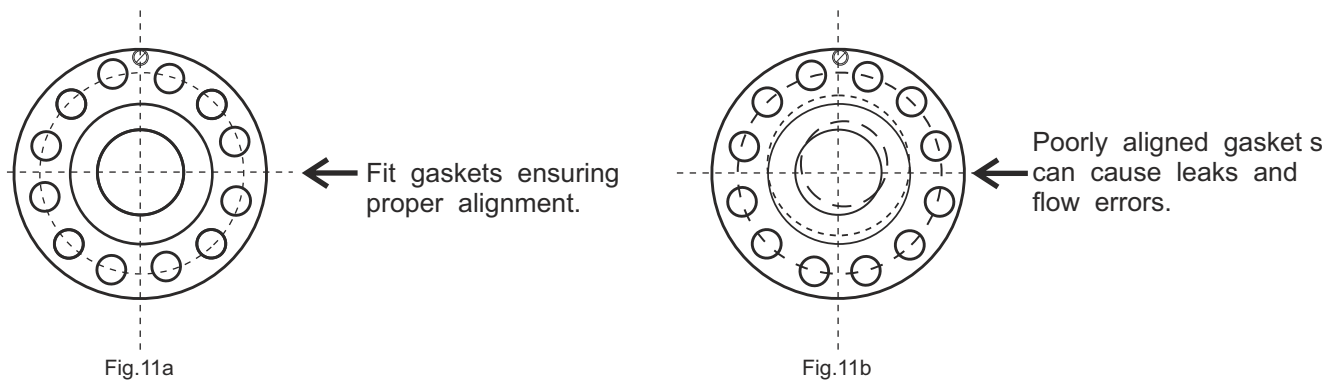

Fig.11 Gasket Alignment

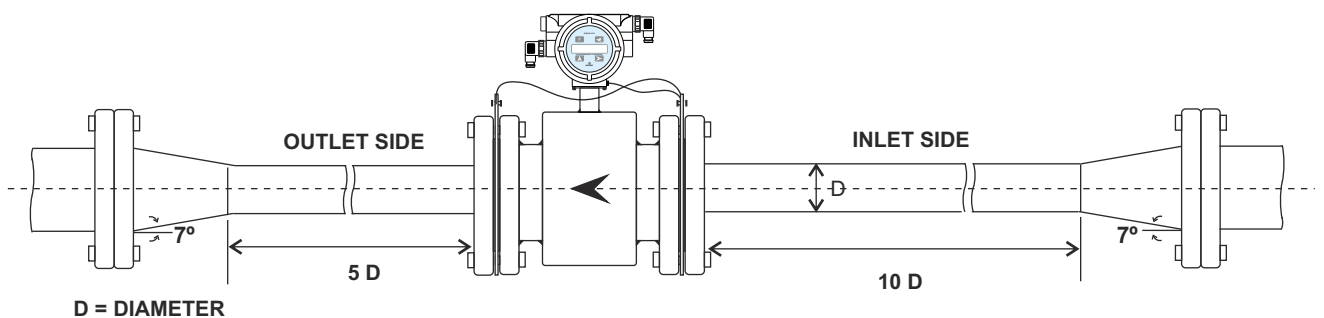

Fig.12 Flow Meter Installation With Reducer

- 6) If pipeline is bigger than the size of flow meter, use Reducers as shown in Fig-10
- 7) At inlet side, straight run to be maintained 10 times of flow meter bore size 'D' and similarly 5 times of 'D' at outlet side.
- 8) Flange size to be selected as per pipeline and flow meter size.

9.2 Safety Precautions :

- Flow meter must be properly grounded or earth according to local electric codes.
- Install signal wiring separate from the high voltage power cable.

9.3 Installation Position:

a) Horizontal Position:

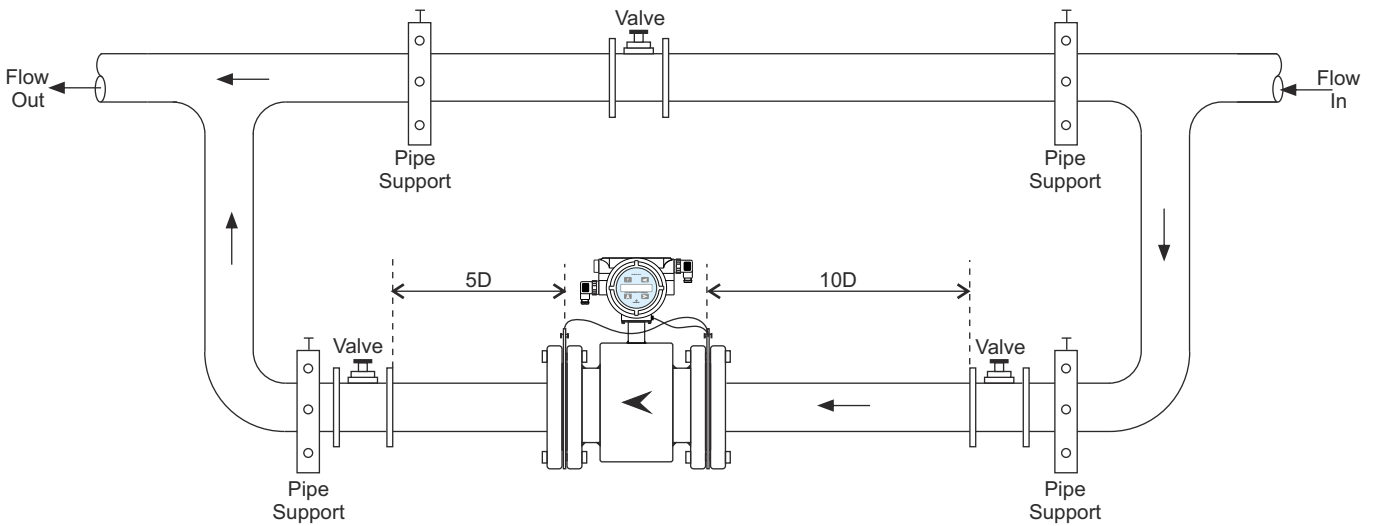

Fig.13 FLOW METER INSTALLATION IN HORIZONTAL POSITION

b) Vertical Position:

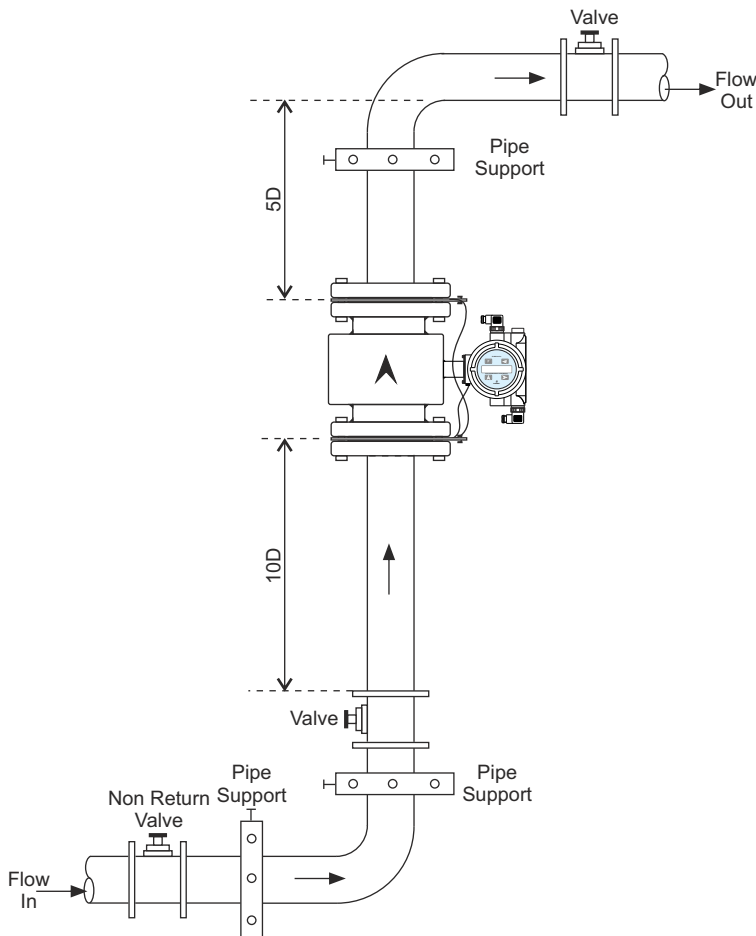
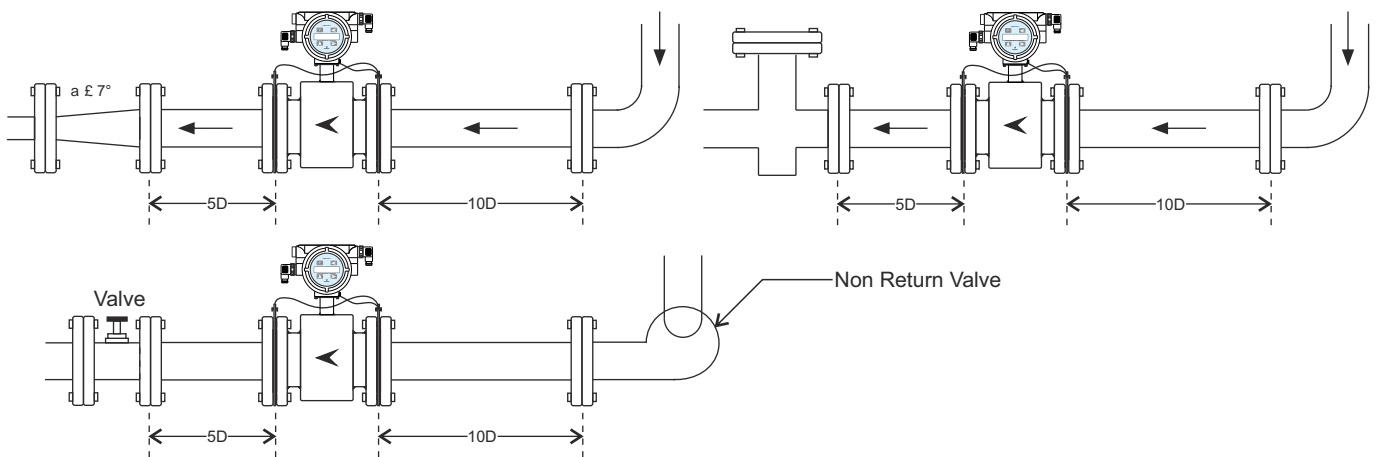

Fig.14 FLOW METER INSTALLATION IN VERTICAL POSITION

9.4 Pipe System :

1. The flow sensor must be mounted in a location which is free from interfering elements like valves, Ts, bends, pumps, etc. to ensure a laminar flow without turbulence upstream of the flow sensor. For that reason the flow sensor must be mounted in a straight pipe at a distance from interfering elements of minimum 10 x DN upstream and minimum 5 x DN downstream.



Important: Valves should always be mounted on the downstream side of the flow sensor!

2. If it becomes necessary to use reducers, the inner angle must not exceed 7°.

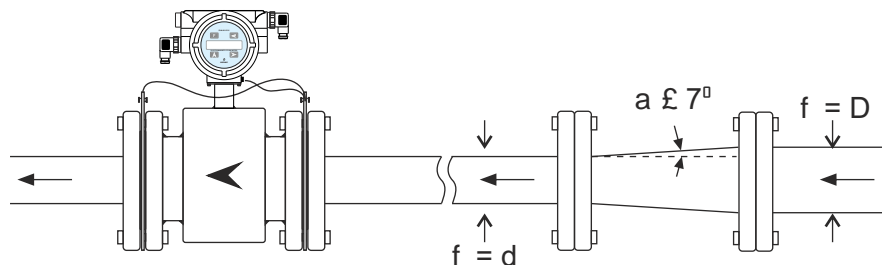

The minimum length to keep the angle below 7° can be checked by means of the formula below:
 $L = (D - d) / (2 \times \tan a)$ where "D" is the large diameter and "d" the small diameter of the reducer.
 Example: If a flow sensor in dimension DN 65 is mounted downstream of a 80 mm pipe, the reducer must then have a length of minimum 108.80 mm in order to keep the inner angle below 7°.

3. Flange connections must be assembled concentrically on both the upstream and the downstream side. Due to improper connection assuring accuracy of flow meter will be affected.
 Note:- Gaskets and grounding rings must also be mounted concentrically!

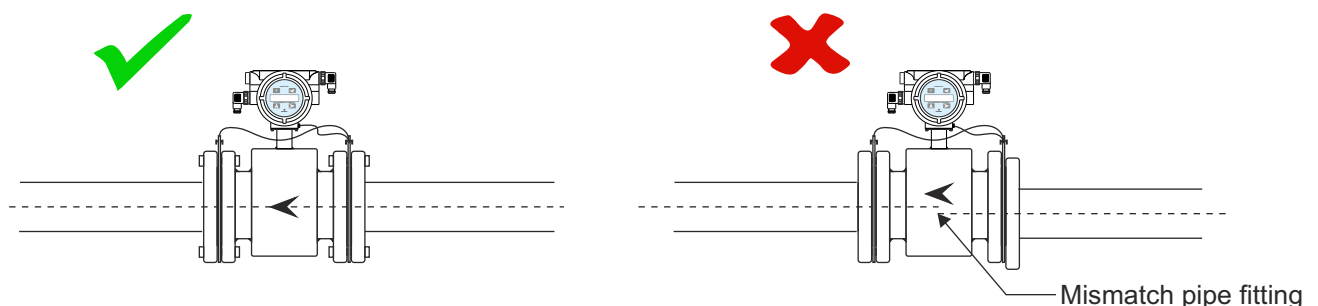

4. The flow sensor should always be filled with liquid. For that reason the flow sensor must not be mounted at the highest point of the pipe system or in free outlets, where gravity could empty or partially empty the pipe.

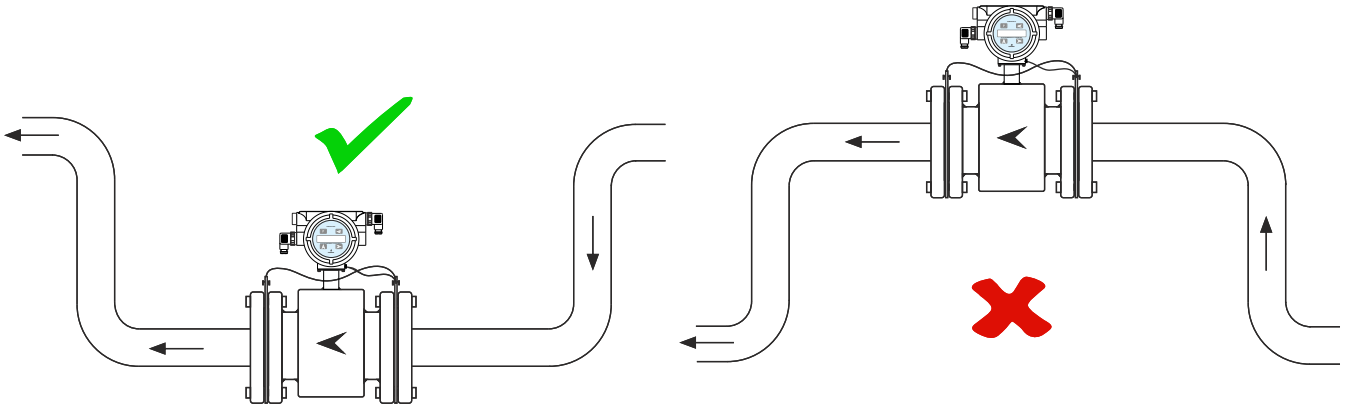

5. The flow sensor can be mounted vertically or horizontally . If the flow sensor is mounted vertically , the flow direction should always be upwards. In that way the effect from possible bubbles in the liquid will be significantly reduced, just as it will ensure that the flow sensor is always filled with liquid. In case the liquid is carrying particles, for example when measuring sludge, sewage, etc., the flowsensor must be mounted vertically .

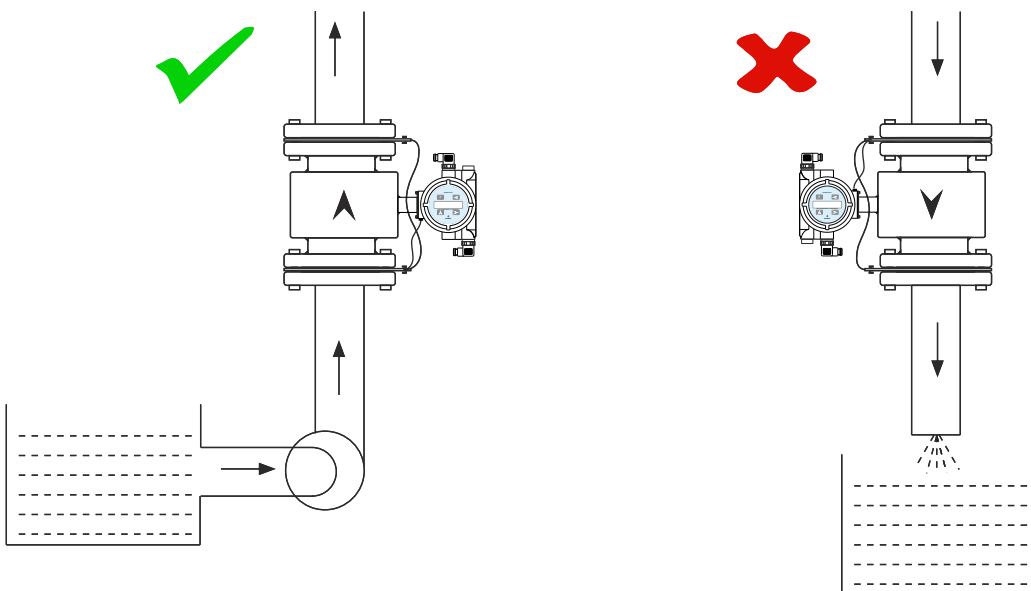

6. When mounting horizontally in pipes with free downstream outlet, the flow sensor should be mounted such that it will always be filled with liquid, for example in a bend situated lower than the height of the outlet. **In case the liquid is carrying particles, e.g. when measuring sludge, Sewage etc. the flow sensor must be mounted vertically.**

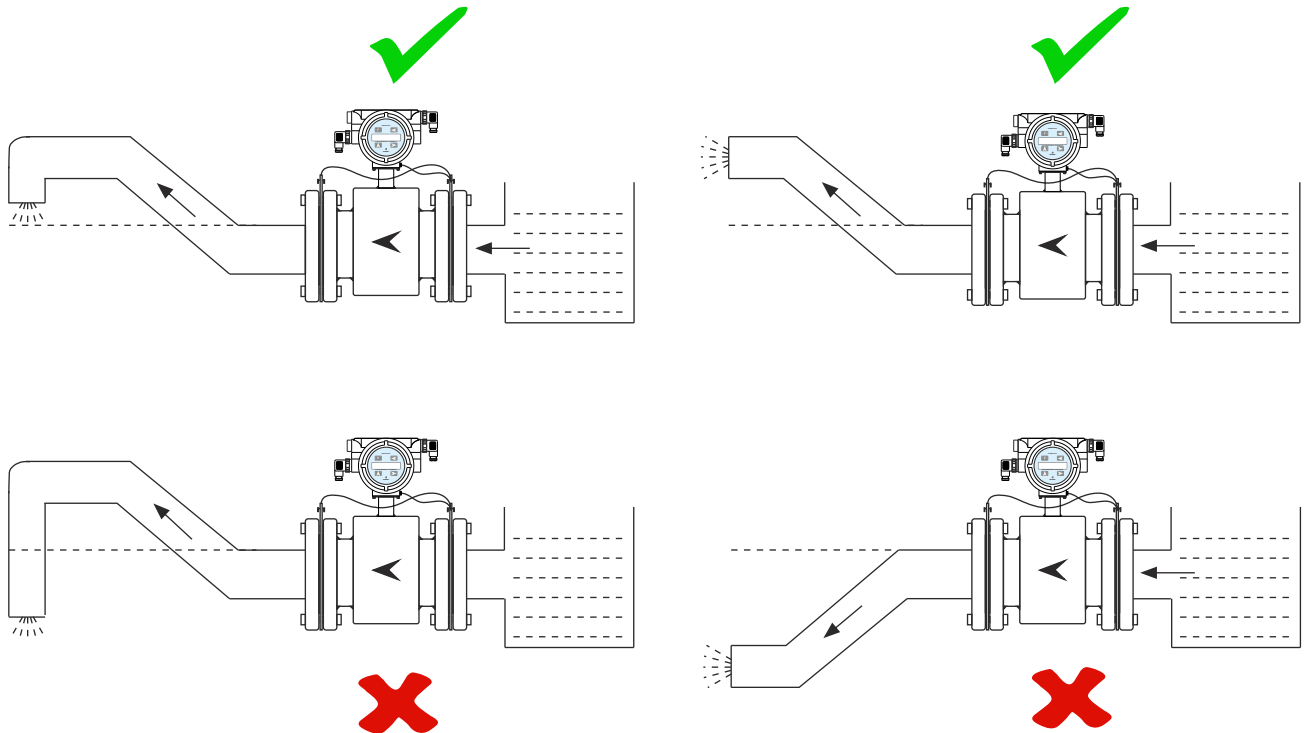

7. When mounting horizontally the flow sensor can be rotated max. $\pm 45^\circ$ seen from the connection end. If the flow sensor is rotated more than 45° , one of the electrodes may not be in full contact with the liquid.

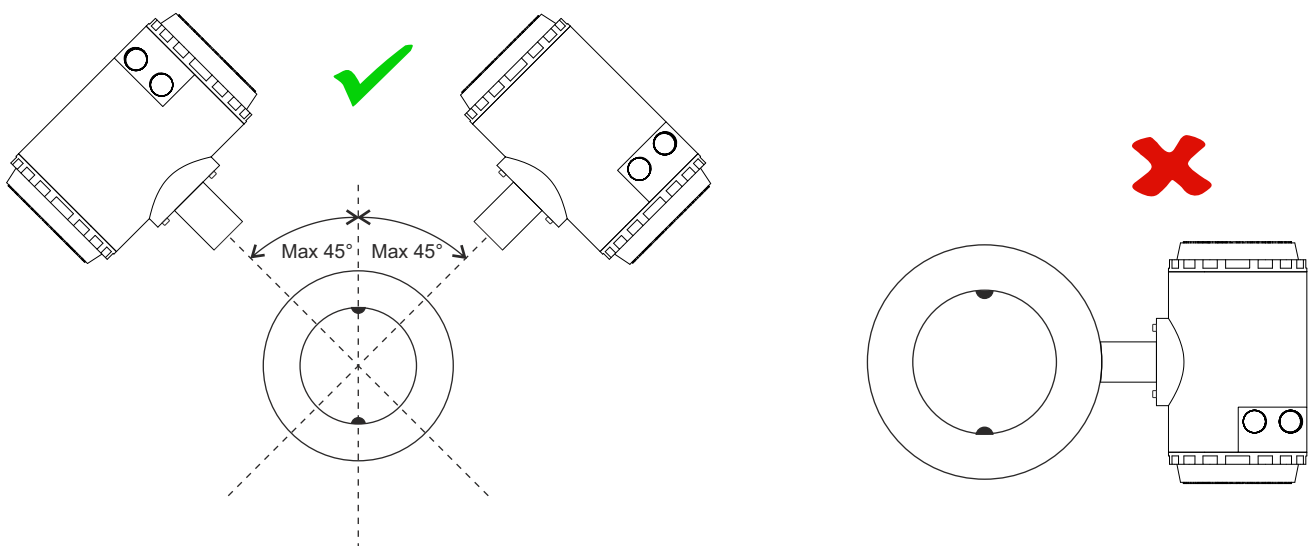

10. OPERATIONAL FLOW CHART

10.1 General Overview of Operations :

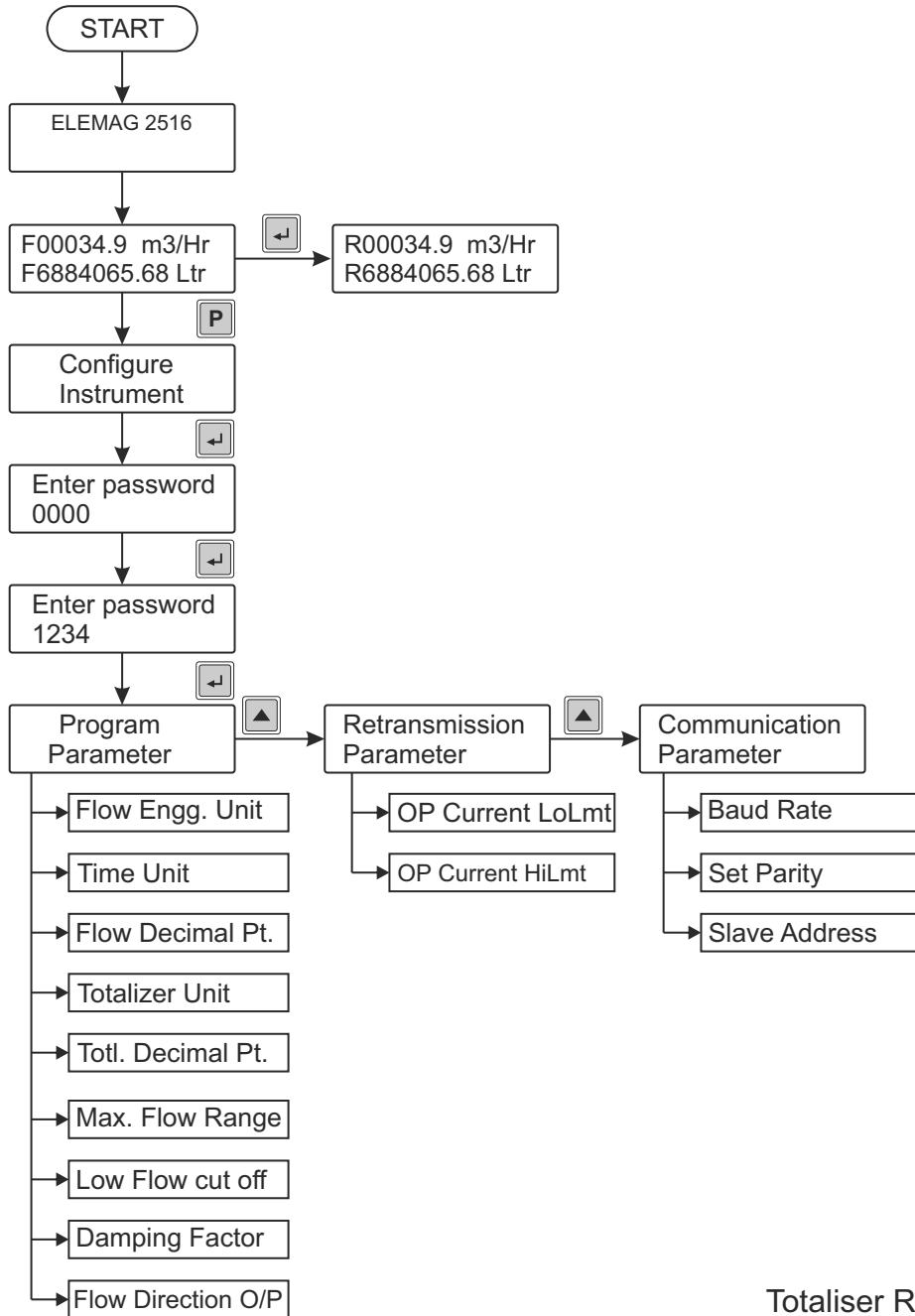

10.1.1 Power ON Messages :

Prog Parameters error	Prog Parameters error occurs if you have not set the Program parameters.	F00034.9 m3/Hr F6884065.68 Ltr	To display normal Flow & Totaliser value.
ELMAG2516_R0	To display software version name.	Pipe is Empty F6884065.68 Ltr	If pipe is not fill display pipe is Empty message.
SERIAL NUMBER: 123456	To display instrument serial number.	Excitation Error F6884065.68 Ltr	If coil connection is not proper or loose display Excitation error message.

10.2 Configure Mode :

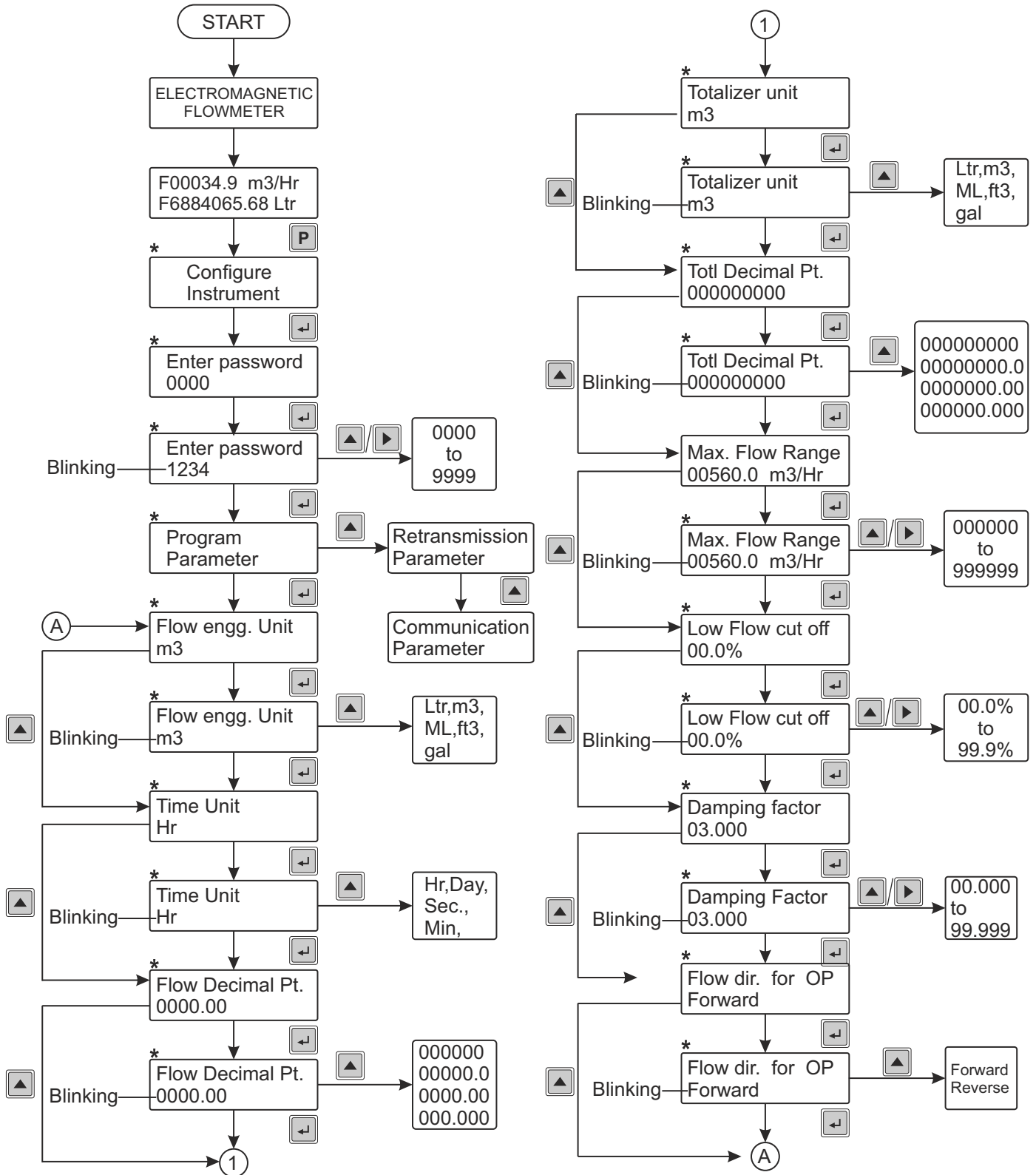

* Press **P** To Exit to higher level menu

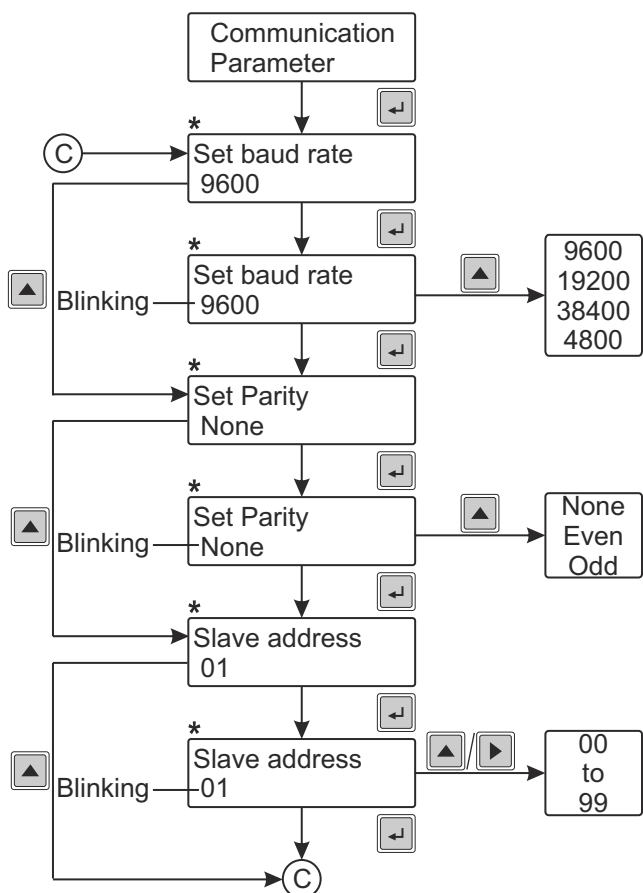
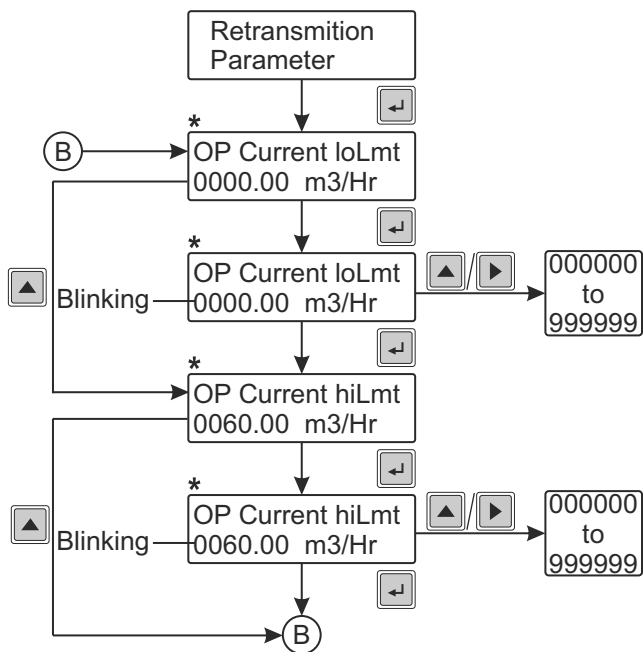

* Press **P** To Exit to higher level menu

10.3 Configure Instrument Method :

10.5.1 Program Parameter :

System offers user to set flow unit, Totaliser unit, Decimal point, max flow range, Low flow cut off limit, damping factor, etc.

1] Power On the instrument. Display will show

F00034.9 m3/Hr
F6884065.68 Ltr

2] Press  key. Display will show

Configure Instrument

3] Press  key. Display will show

Enter Password
0000

Enter the password 1234 using  &  key.

4] Press  key. Display will show

Program Parameter

Press  key display will show

Flow Engg. Unit
m3

Press  key. Display will blink. The  key is used to change Engg. unit.

Press  key to store Engg. unit.

5] Now, Display will show



Time Unit
Hr

Press  key. Now the display will blink. The  key is used to change time unit.

Press  key to store time unit.

6] Display will show

Flow Decimal Pt.
000.000

Press  key. The numeric digit will start to blink. Press the  key to change the position of decimal point. Press  key to store position of decimal point.

7] Display will show



Totalizer unit
m3

Press  key. Display will blink. Press the  key to change totaliser unit .



Press  key to store totaliser unit.

8] Display will show

Totl Decimal Pt.
000000.000

Press  key. Now the display will blink. Press the  key to change the position of decimal point. Press  key to store position of decimal point.

11] Now, Display will show Max. Flow Range
056.000 m3/Hr

Press  key. The numeric digit will blink. Enter the desired value one by one using  &  key.

Press  key to store max flow range value.

12] Display will show Low Flow cut off
00.0%

Press  key. The display will blink. Enter the desired value using  &  key.

It is the integer value below which the display & the Ret. Output shows the lower limit value.

Press  key to store value

13] Now, Display will show Damping Factor
03.000

Press  key. The display will blink. Enter the desired value using  &  key.

It is Number of ADC count of which average is taken to stabilize the display.

14] Now, Display will show Flow dir. for OP
Forward

Press  key. The display will blink. Enter the desired flow direction press  key.



15] Press three times  key. Go to RUN mode.

10.5.2 Retransmission output configuration

Retransmission output can be configured to process flow range. 'OP Current LoLmt' and 'OP Current HiLmt' will be configured to 4mA and 20mA respectively.

1] Power On the instrument. Display will show F00034.9 m3/Hr
F688465.68 Ltr L





2] Press  key. Display will show Configure
Instrument

3] Press  key. Display will show Enter Password
0000 Enter the password 1234 using  &  key.

4] Press  key. Display will show Program
Parameter



Then press  key display will show Retransmission
Parameter

Press  key display will show OP Current LoLmt
000.000 m3/Hr

Press  key. The numeric digit will blink. Enter the desired value one by one using  &  key. Press  key to store value.

5] Press  key display will show

OP Current HiLmt 060.000 m3/Hr

 Press  key, numeric digit will start blink.
Enter the desired value one by one using  &  key.
Press  key to store value.

6] Press three times  key. Go to RUN mode.

10.5.3 Communication Parameter Setting :

System is able to communicate with PLC or control system with MODBUS RTU protocol .
RS485 or RS232 can be used for MODBUS RTU protocol.

1] Power On the instrument. Display will show



F00034.9 m3/Hr F688465.68 Ltr L

2] Press  key. Display will show

Configure Instrument

3] Press  key. Display will show

Enter Password 0000

 . Enter the password 1234 using  &  key.

4] Press  key. Display will show

Program Parameter

Then press  key display will show

Retransmission Parameter

Now again press  key display will show

Communication Parameter

5] Press  key. Display will show

Set baud rate 9600

 . Now Press  key the display will blink.

The  key is used to change baud rate. Press  key to enter & store baud rate value.

6] Display will show



Set Parity None

Press  key. Now the display will blink. The key is used to change parity type.

Press  key to store parity type.

8] Display will show

Slave Address 01

Press  key. The numeric digit will blink. Enter the desired value one by one using  &  key.

Press  key to store slave address

10.4 Procedure for Average Flow Rate :-

Display in RUN mode. Press  key 5 to 6 Sec

Now, Display will show

Instantaneous flow rate	Previous Average flow rate
F000.004	010.004
F00029030.0; m3	
Totaliser	Totaliser Unit

get the average flow rate. Press  key to start averaging.

Now to get the average flow rate. Press  key.

Display will show

Instantaneous flow rate	Previous Average flow rate
F000.004	010.004
F00029030.0; m3	
Totaliser	Totaliser Unit

Press  key. to go to RUN mode.

10.5 Online Diagnostic Features :

10.7.1 Empty Pipe Indication:- For proper functioning of electromagnetic flow meter, flow tube should always be completely filled, So it is important to detect whether flow tube is filled or empty. 'Pipe Empty' message is displayed on display whenever flow tube is empty. Output current is 3.6 mA during empty pipe condition.

10.7.2 Flow Over Range :- 'Flow Over Range' message is displayed whenever flow rate exceeds 110% of calibration Range. For e.g. If Range is 0 -350.0 m³/hr, then flow meter will show reading up to 385.0 m³/hr i. e. 110 %. If flow exceeds 385.0 m³/hr display will show 'Flow Over Range' message Ret. output will also be 21.60 mA (max.) at 385.0 m³/hr.

10.7.3 Average Flow Rate :- This feature is used to calculate average value of flow rate over a given period of time. It is extremely useful whenever flow rate is fluctuating and we are required to know what is the average flow rate over a given period of time.

11. MODBUS (RS 485) COMMUNICATION DETAILS

11. 1 To view parameters :

Note: Program below parameters before starting communication

1. Baud Rate :9600 / 19200 / 38400 / 4800
2. Parity : None/Odd/Even
3. Slave Address : Selectable 01 to 99
4. Length : 13
5. Communication Protocol: Modbus RTU

COMMUNICATION FORMAT

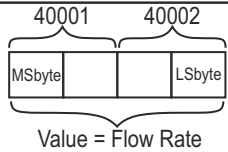
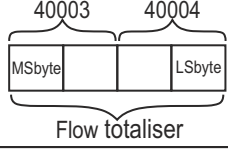
Sr. No.	Function Code	Command	Register Address	Data Format	Details
1	0x04	Read holding Register	40001	Swapped Float	
			40002		
			40003	Swapped Float	
			40004		
			40005	Integer (Hex)	Flow Decimal Value 0 = 0000 1 = 000.0 2 = 00.00 3 = 0.000
			40006	Integer (Hex)	Flow Volume Unit Value 0 = Ft3 1 = gal 2 = Ltr 3 = m3 4 = ML
			40007	Integer (Hex)	Flow Time Unit Value 0 = Sec 1 = Min 2 = Hr 3 = Day
			40008	Integer (Hex)	Totaliser Decimal Value 0 = 0000 1 = 000.0 2 = 00.00 3 = 0.000
			40009	Integer (Hex)	Totaliser Engg. Unit Value 0 = Ft3 1 = gal 2 = Ltr 3 = m3 4 = ML

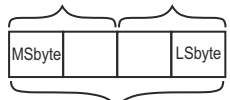
Sr. No.	Function Code	Command	Register Address	Data Format	Details
1	0x04	Read holding Register	40010	Swapped Float	 <p>Value = Reverse Flow Totaliser</p>
			40011		
			40012	Integer (Hex)	Reverse Flow Enable / Disable 0 = Disable 1 = Enable
			40013	Integer (Hex)	Current Flow Direction 0 = Forward 1 = Reverse

12. DOS & DON'TS

General mishandling on site :

1. Application of power supply 230 V AC OR 24V DC at incorrect terminals like input .
2. Loose connection on terminations.
3. Incorrect calibration.

Precautions to be taken on site :

1. Read the instruction manual carefully before installing the instrument.
2. Do the connections as per the termination details given in the manual.
3. Terminal connections should be tight.
4. Check for proper supply voltage.
5. During calibration, follow the steps mentioned in the manual.
6. Verify that earthing is proper.

13. TROUBLE SHOOTING PROCEDURE

SYMPTOMS	CAUSE OF FAILURE	ACTION TO BE TAKEN
No display indication	<ol style="list-style-type: none"> 1. Absence of power supply at terminal block 2. Loose connection on termination. 	<ol style="list-style-type: none"> 1. Check power supply connections & rectify the fault. 2. Tight the termination connections.
Incorrect display indication.	<ol style="list-style-type: none"> 1. Incorrect calibration. 	<ol style="list-style-type: none"> 1. Recalibrate the instrument. Refer calibration procedure.
Flow is not registered at all.	<ol style="list-style-type: none"> 1. Reverse flow direction. 	<ol style="list-style-type: none"> 1. Check for correct flow measurement direction as indicated by arrow on the flowmeter.
Incorrect retransmission output.	<ol style="list-style-type: none"> 1. Retransmission output calibration disturbed. 	<ol style="list-style-type: none"> 1. Recalibrate the instrument for retransmission output. Refer calibration procedure.

Periodical maintenance :

The flow meter does not require any special maintenance. Dependent on the media being measured it is recommended that approx. once a year, remove the sensor from the pipe and clean the liner. Method of cleaning consists of removing mechanical dirt and any non conductive coating (like oil film) from the liner. A very dirty liner could cause inaccuracy of the measurement. Check mechanical state of the liner

Authorised Dealer

	<p><i>NK Instruments Pvt. Ltd.</i></p> <p>B-501/504, 5th floor, Raunak Arcade, Near THC Hospital, Gokhale Road, Naupada, Thane(W) 400602. Maharashtra INDIA E-Mail: sales@nkinstruments.com Skype: nitinkelkarskye</p>	
---	--	---